

AN EXTENSION OF THE CLASSIFICATION OF HIGH RANK REGULAR POLYTOPES

MARIA ELISA FERNANDES, DIMITRI LEEMANS, AND MARK MIXER

ABSTRACT. Up to isomorphism and duality, there are exactly two nondegenerate abstract regular polytopes of rank greater than $n - 3$ (one of rank $n - 1$ and one of rank $n - 2$) with automorphism groups that are transitive permutation groups of degree $n \geq 7$. In this paper we extend this classification of high rank regular polytopes to include the ranks $n - 3$ and $n - 4$. The result is, up to isomorphism and duality, there are exactly seven abstract regular polytopes of rank $n - 3$ for each $n \geq 9$, and there are nine abstract regular polytopes of rank $n - 4$ for each $n \geq 11$. Moreover, we show that if a transitive permutation group Γ of degree $n \geq 11$ is the automorphism group of an abstract regular polytope of rank at least $n - 4$, then $\Gamma \cong S_n$.

1. INTRODUCTION

Abstract polytopes are incidence structures generalizing certain discrete geometric objects, such as the Platonic solids. Abstract regular polytopes are those that are richest in symmetry. The one-to-one correspondence between abstract regular polytopes and a class of groups known as string C-groups, which are themselves quotients of Coxeter groups, has led to many papers which study when abstract regular polytopes have certain groups as their group of automorphisms.

Much of the work in this area has been influenced by databases of examples of polytopes and their automorphism groups. In 2006, D. Leemans and L. Vauthier published *An atlas of polytopes for almost simple groups*, [23] classifying all abstract regular polytopes whose automorphism group is an almost simple group as large as the automorphism group of a simple group with 900,000 elements. Also in 2006, M. Hartley published *An atlas of small regular polytopes*, [15], where he classified all regular polytopes with automorphism groups of order at most 2000 (not including orders 1024 and 1536). In [16], M. Hartley and A. Hulpke classified all regular polytopes for the sporadic groups as large as the Held group, and Leemans and Mixer classified, among others, all regular polytopes for the third Conway group [19]. More recently, T. Connor, Leemans, and Mixer classified all regular polytopes of rank at least four for the O’Nan sporadic simple group [9].

These collections of polytopes helped lead to various theoretical results about abstract regular polytopes with automorphism group G an almost simple group, where $\text{PSL}(2, q) \leq G \leq \text{P}\Gamma\text{L}(2, q)$, or G is one of $\text{PSL}(3, q)$, $\text{PGL}(3, q)$, $\text{Sz}(q)$, $R(q)$, S_n , or A_n (see [2, 6, 8, 11–13, 17, 18, 20–22]). Table 1 summarizes the results obtained for the symmetric groups S_n . The results for $5 \leq n \leq 9$ can be found in [23], and

Received by the editors September 5, 2017, and, in revised form, October 4, 2017.

2010 *Mathematics Subject Classification*. Primary 52B11, 20D06.

Key words and phrases. Abstract regular polytopes, string C-groups, permutation groups.

TABLE 1. Number of polytopes for S_n ($5 \leq n \leq 14$).

$G \backslash \text{Rank}$	3	4	5	6	7	8	9	10	11	12	13
S_5	4	1	0	0	0	0	0	0	0	0	0
S_6	2	4	1	0	0	0	0	0	0	0	0
S_7	35	7	1	1	0	0	0	0	0	0	0
S_8	68	36	11	1	1	0	0	0	0	0	0
S_9	129	37	7	7	1	1	0	0	0	0	0
S_{10}	413	203	52	13	7	1	1	0	0	0	0
S_{11}	1221	189	43	25	9	7	1	1	0	0	0
S_{12}	3346	940	183	75	40	9	7	1	1	0	0
S_{13}	7163	863	171	123	41	35	9	7	1	1	0
S_{14}	23126	3945	978	303	163	54	35	9	7	1	1

the regular polytopes for larger S_n are computed using the algorithms developed in [19].

Julius Whiston showed in [27] that the maximum size of an independent generating set of a permutation group of degree n is $n - 1$. Thus the rank of an abstract regular polytope whose automorphism group is a permutation group of degree n is at most $n - 1$. Motivated by the data in Table 1, Fernandes and Leemans proved in [11] that there is exactly one such polytope up to isomorphism when $n \geq 5$ and that when $n \geq 7$, there is also a unique polytope of rank $n - 2$ up to isomorphism and duality and that for each rank $3 \leq r \leq n - 1$, there is at least one abstract regular polytope of rank r whose automorphism group is S_n .

In this article, we extend the results of [11] by giving a classification of rank $r \geq n - 4$ string C-groups with connected diagram for transitive groups of degree n with n sufficiently large. We study such string C-groups using an associated graph called a permutation representation graph, which we define in Section 2. The main theorem of this article is the following.

Theorem 1.1. *Let $x \in \{1, 2, 3, 4\}$ and $n \geq 3 + 2x$ when $r = n - x$. If Γ is a string C-group of rank $r \geq n - x$ with a connected diagram and is isomorphic to a transitive group of degree n , then Γ is isomorphic to S_n . Furthermore, Γ has a permutation representation graph shown in Figure 1.*

Many results in this paper will be derived from the structure of the maximal parabolic subgroups of Γ , i.e., the subgroups generated by all but one of the generators of Γ . In particular, in the case where all maximal parabolic subgroups of Γ are intransitive, we improve the techniques used in [11]. In the case where a maximal parabolic subgroup of Γ is transitive, we rely on the main theorem of [5]. The cases where $r = n - 1$ and $r = n - 2$ are much easier to prove using this approach, and thus we have included these cases in the present article, even though these cases have been previously proven.

The article is organized as follows. In Section 2, we give the definitions and notation needed to understand this article. In Section 3, we use *fracture graphs* to classify the possible permutation representation graphs of a rank $n - 3$ or $n - 4$ string group generated by involutions with only intransitive maximal parabolic subgroups. In Section 4, we prove that exactly seven of these possibilities yield a rank $n - 3$ string C-group and exactly nine yield a rank $n - 4$ string C-group.

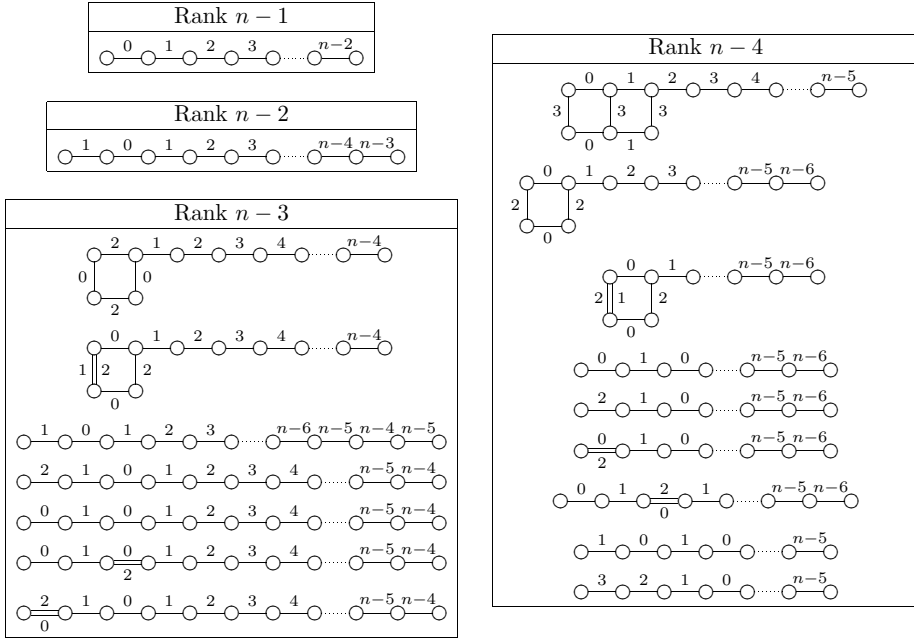

FIGURE 1. Permutation representation graphs for nondegenerate transitive string C-groups of rank $r \geq n - 4$.

Finally, in Section 5, we show that only the cases appearing in Section 4 may occur by proving that, under the hypotheses of Theorem 1.1, all maximal parabolic subgroups must be intransitive.

2. PRELIMINARIES

2.1. String C-groups. A Coxeter group $\Gamma := (G, S)$ of rank r is a group G with a set S of distinguished generators $\rho_0, \dots, \rho_{r-1}$ and presentation

$$\langle \rho_i \mid (\rho_i \rho_j)^{m_{i,j}} = \varepsilon \text{ for all } i, j \in \{0, \dots, r - 1\} \rangle,$$

where ε is the identity element of G and each $m_{i,j}$ is a positive integer or infinity, $m_{i,i} = 1$, and $m_{i,j} > 1$ for $i \neq j$. All Coxeter groups also satisfy the next condition, which is called the *intersection property*:

$$\forall J, K \subseteq \{0, \dots, r - 1\}, \langle \rho_j \mid j \in J \rangle \cap \langle \rho_k \mid k \in K \rangle = \langle \rho_j \mid j \in J \cap K \rangle.$$

A Coxeter group Γ can be represented by a *Coxeter diagram* \mathcal{D} . This Coxeter diagram \mathcal{D} is a labelled graph which represents the set of relations of G . More precisely, the vertices of the graph correspond to the generators ρ_i of G , and for each i and j , an edge with label $m_{i,j}$ joins the i th and the j th vertices; conventionally, edges of label 2 are omitted. By a *string diagram* we mean a Coxeter diagram with each connected component linear. A Coxeter group with a string diagram is called a *string Coxeter group*.

More generally, a *string group generated by involutions*, or *sggi* for short, is defined as a group generated by pairwise distinct involutions $\rho_0, \dots, \rho_{r-1}$ that satisfy

the following property, called the *commuting property*:

$$|i - j| > 1 \Rightarrow (\rho_i \rho_j)^2 = 1.$$

The (*Schläfli*) *type* of Γ is $\{p_1, \dots, p_{r-1}\}$, where p_i is the order of $\rho_{i-1}\rho_i$, $i \in \{1, \dots, r - 1\}$, and the *rank* of an sggi is the size of its set of generators. The *dual* of an sggi is obtained by reversing the order of the generators. Finally, a *string C-group* Γ is an sggi satisfying the intersection property. In this case the underlying diagram for Γ is a string diagram. Clearly the dual of a string C-group is itself a string C-group.

A string C-group is called *degenerate* if its Schläfli type contains a 2. It is called *nondegenerate* otherwise.

In [25], it was shown that string C-groups and abstract regular polytopes are in one-to-one correspondence.

Let $\Gamma = \langle \rho_0, \rho_1, \dots, \rho_{r-1} \rangle$ be an sggi. We denote by Γ_j for $0 \leq j \leq r - 1$ the group generated by $\{\rho_i \mid i \neq j\}$, by $\Gamma_{<j}$ the group generated by $\{\rho_i \mid i < j\}$, by $\Gamma_{>j}$ the group generated by $\{\rho_i \mid i > j\}$, and we write Γ_{j_1, \dots, j_k} with $\{j_1, \dots, j_k\} \subset \{0, \dots, r - 1\}$, to denote the group generated by $\{\rho_i \mid i \neq j_1, \dots, j_k\}$. The subgroups Γ_i with $0 \leq i \leq r - 1$ are called the *maximal parabolic subgroups*.

Let $\Gamma = \langle \rho_0, \dots, \rho_{r-1} \rangle$ be an sggi acting as a permutation group on a set $\{1, \dots, n\}$. We define the *permutation representation graph* \mathcal{G} as the r -edge-labelled multigraph with n vertices and with a single i -edge $\{a, b\}$ whenever $a\rho_i = b$ with $a \neq b$. Note that each of the generators is an involution; thus the edges in our graph are not directed. When Γ is a string C-group (a regular polytope), the multi-graph \mathcal{G} is called a *CPR graph*, as defined in [26], and satisfies the following proposition.

Proposition 2.1 ([26, Proposition 3.5]). *Let \mathcal{G} be a CPR graph of a regular polytope, and let $|i - j| \geq 2$. Then every connected component of $G_{i,j}$ is either a single vertex, a single edge, a double edge, or an alternating square.*

Note that to any set of permutations one can associate a “permutation directed graph” by labeling each directed edge with a permutation from the set. Furthermore, if the permutations naturally arise in a list, then you can simply label the directed edges with the position in the list. Since our permutations are all involutions, we do not need directed edges. This notion of an undirected permutation representation graph applies equally well to a set of involutions, but we are most interested in the graphs arising from the generators of string groups. Conversely, it is worth noting that each permutation representation graph uniquely determines a list of involutions in S_n .

Let $\Gamma = \langle \rho_0, \dots, \rho_{r-1} \rangle$ be a subgroup of S_m , and let τ be an involution in S_m such that $\tau \notin \Gamma$ and τ commutes with all of Γ . We define a *sesqui-extension* of Γ with respect to ρ_k and τ as the group $\Gamma^* = \langle \rho_i \tau^{\eta_i} \mid i \in \{0, \dots, r - 1\} \rangle$, where $\eta_i = 1$ if $i = k$ and 0 otherwise (see [12]).

3. INTRANSITIVE MAXIMAL PARABOLIC SUBGROUPS

We start this section with the definition of fracture graphs. These graphs will play a central role in the case where all maximal parabolic subgroups of Γ are intransitive. Throughout this section, Γ denotes a transitive permutation group of degree n with the following properties: it is a rank r string group generated by involutions, all its maximal parabolic subgroups are intransitive, and it has no 2s

in its Schläfli type. Furthermore, \mathcal{G} is the permutation representation graph of Γ , and \mathcal{F} is a fracture graph of Γ as defined below.

Definition 3.1. Let \mathcal{G} be the permutation representation graph of Γ . A *fracture graph* \mathcal{F} of Γ is a subgraph of \mathcal{G} containing all vertices of \mathcal{G} and one edge of each label, chosen in such a way that each i -edge joins two vertices a_i and b_i that are in distinct Γ_i -orbits.

Observe that fracture graphs have exactly r edges and are well defined as long as every Γ_i is intransitive.

In the following figures, we adopt the following notation. We represent the edges of \mathcal{G} that are in \mathcal{F} by solid edges. We represent the edges of \mathcal{G} that are not in \mathcal{F} by dashed edges. To represent edges with consecutive labels $i + 1, \dots, j - 1$ that belong to \mathcal{F} , we use dotted lines between two solid edges with labels i and j .

Lemma 3.2.

- (1) \mathcal{F} has no cycles.
- (2) \mathcal{F} has c connected components if and only if $r = n - c$.
- (3) If there exist two edges $\{a, b\}$ with distinct labels i and j in \mathcal{G} , then a and b are in distinct connected components of \mathcal{F} .
- (4) If there exist two i -edges $\{a, b\}$ and $\{c, d\}$ in \mathcal{G} , then not all vertices a, b, c, d are in the same connected component of \mathcal{F} .

Proof.

- (1) Let $\{a, b\}$ be the i -edge of \mathcal{F} . Suppose that this edge is in a cycle of \mathcal{F} . Then a and b are in the same Γ_i -orbit, a contradiction with Definition 3.1.
- (2) This is a consequence of (1), which shows that \mathcal{F} is a forest.
- (3) Suppose on the contrary that a and b are in the same connected component of \mathcal{F} . Then there exists a path in \mathcal{F} from a to b . Let $\{c, d\}$ be an l -edge of this path. The vertices c and d are then necessarily in the same Γ_l -orbit, a contradiction to Definition 3.1.
- (4) At least one of the i -edges, say $\{a, b\}$, of \mathcal{G} is not in \mathcal{F} . Suppose that a, b, c, d are all in the same connected component of \mathcal{F} . Then there is a path in \mathcal{F} from a to b . If $\{e, f\}$ is an l -edge on this path, then the vertices e and f are in the same Γ_l -orbit, a contradiction as before. Thus not all vertices a, b, c, d are in the same connected component of \mathcal{F} . □

Lemma 3.3. *If a cycle C of \mathcal{G} contains the i -edge of \mathcal{F} , then C contains another i -edge.*

Proof. Suppose that a cycle of \mathcal{G} contains exactly one i -edge $e = \{a, b\}$. Then a and b are in the same Γ_i -orbit, and therefore e is not in \mathcal{F} by Definition 3.1. □

Lemma 3.4. *If there is a cycle C in \mathcal{G} containing exactly two i -edges e_1, e_2 such that e_1 is in \mathcal{F} , then there is another fracture graph \mathcal{F}' obtained by removing e_1 and adding e_2 .*

Proof. Suppose that $e_2 = \{a, b\}$ with a and b in the same Γ_i -orbit. Then e_1 is the unique i -edge in a cycle of \mathcal{G} , contradicting Lemma 3.3. Thus replacing e_1 by e_2 we obtain another fracture graph. □

Lemma 3.5. *If a and b are vertices in the same connected component of \mathcal{F} and $e = \{a, b\}$ is an i -edge in \mathcal{G} , then e is in \mathcal{F} .*

Proof. As a and b are vertices in the same connected component of \mathcal{F} , there exists a path P in \mathcal{F} connecting a to b . Suppose that e is not in \mathcal{F} . Then there exists a j -edge in P with $j \neq i$. As e is an i -edge of \mathcal{G} there exists a cycle containing the j -edge of \mathcal{F} that does not contain any other j -edge, contradicting Lemma 3.3. \square

Lemma 3.6. *Let v and w be vertices of an alternating square as in the following figure:*

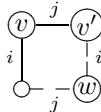

Then v and w are in different connected components of \mathcal{F} .

Proof. Suppose that v and w are in the same connected component of \mathcal{F} . Then also v' , as in the picture, is in the same connected component of w . Hence the i -edge $\{v', w\}$ must be in \mathcal{F} , by Lemma 3.5. Thus \mathcal{F} has two i -edges, a contradiction. \square

Lemma 3.7. *Consider the alternating square, as in the following figure, having an i -edge in \mathcal{F} and both j -edges not in \mathcal{F} :*

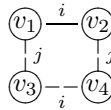

Then $v_1, v_3,$ and v_4 are in different connected components of \mathcal{F} .

Proof. As $\{v_1, v_3\}, \{v_3, v_4\},$ and $\{v_2, v_4\}$ are not edges of \mathcal{F} , by Lemma 3.5 each of these pairs of vertices is in a different component of \mathcal{F} . Moreover, all three vertices $v_1, v_3,$ and v_4 must belong to different connected components of \mathcal{F} ; otherwise there is a cycle in \mathcal{G} containing only one i -edge of \mathcal{F} contradicting Lemma 3.3. \square

From now on, we assume that $r \geq n - 4$.

Lemma 3.8. *Let $x \in \{1, 2, 3, 4\}$ and let $n \geq 3 + 2x$ when $r = n - x$. The degree of a vertex of \mathcal{F} is at most 3. Moreover, a vertex of degree 3 in \mathcal{F} has degree 3 also in \mathcal{G} .*

Proof. Suppose that there exists a vertex v of degree ≥ 4 in \mathcal{F} . Let v be incident to four edges with labels i, j, k, l . We may suppose that $i < j < k < l$. Then, by Proposition 2.1, v is a vertex on three alternating squares as in the following figure:

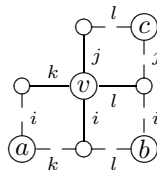

By Lemmas 3.6 and 3.3, v, a, b, c are in different connected components of \mathcal{F} . Therefore \mathcal{F} has at least four connected components. By Lemma 3.2(2), $r = n - 4$ and \mathcal{F} has exactly four connected components, that is, $x = 4$.

As $n \geq 3 + 2 \cdot 4 = 11$ there exists a vertex d incident, in \mathcal{F} , to one vertex of the previous picture. We may assume that d is incident to c in \mathcal{F} . Similar arguments as the ones below permit us to get contradictions when d is incident to any other vertex

of the figure. As $j < k < l$ the label s of the edge $\{c, d\}$ cannot be consecutive with both j and l . Suppose that s is not consecutive with j . Then there is an alternating square containing c and a j -edge as in the following picture:

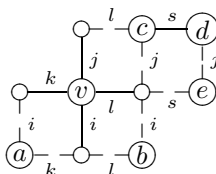

Again by Lemmas 3.4, 3.6, and 3.3, the vertices $v, a, b, c,$ and e are in different connected components of \mathcal{F} , a contradiction to the fact that there are exactly four connected components. If s is consecutive with j , then it is not consecutive with l , and we get the same contradiction using l instead of j .

Finally suppose that a vertex v has degree 3 in \mathcal{F} and has a higher degree in \mathcal{G} . Let v be incident to four edges with labels i, j, k, l . We may suppose that $i < j < k < l$. Suppose that the j -edge containing v is not in \mathcal{F} :

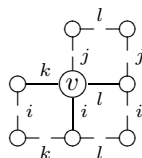

By Lemma 3.4 we may assume that both j -edges of the figure above are not in \mathcal{F} . Then by Lemmas 3.7 and 3.3, we get five connected components for \mathcal{F} , contradicting Lemma 3.2(2). If we assume that another edge incident to v is not in \mathcal{F} , we get the same contradiction. \square

Lemma 3.9. *Let $x \in \{1, 2, 3, 4\}$ and let $n \geq 3 + 2x$ when $r = n - x$. If Γ has a fracture graph having a vertex of degree 3, then $r \in \{n - 4, n - 3\}$ and Γ admits, up to duality, a fracture graph \mathcal{F} from the following list:*

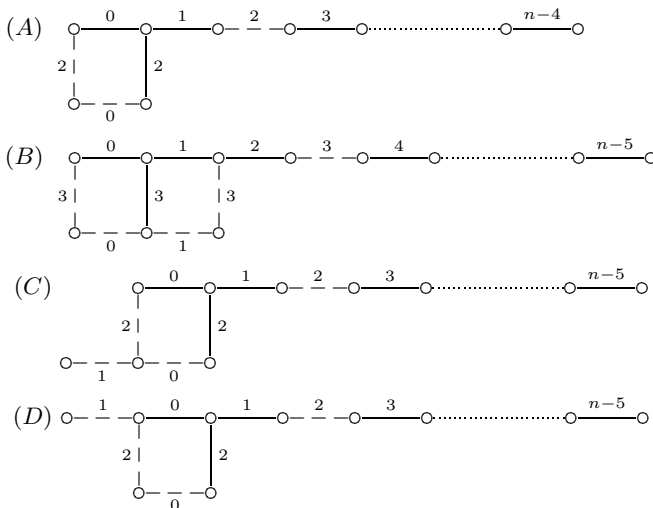

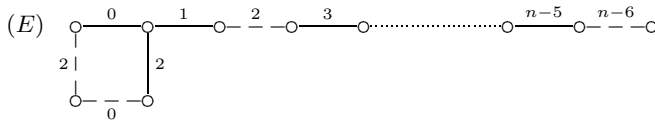

Proof. By Lemma 3.8, we know that the degree of each vertex of \mathcal{F} is at most 3. Let i, j, k be the labels of the edges incident to a vertex v of degree 3 in \mathcal{F} (and hence also in \mathcal{G}) with $i < j < k$ and i being the smallest possible. We may consider, up to duality, the following cases: (1) $j \neq i + 1$ and $k \neq j + 1$; (2) $j = i + 1$ and $k \neq i + 2$; (3) $j = i + 1$ and $k = i + 2$.

Case 1. $j \neq i + 1$ and $k \neq j + 1$. There are three alternating squares in \mathcal{G} as in the following figure:

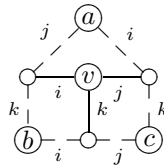

In this case $v, a, b,$ and c are, by Lemmas 3.3 and 3.6, in different connected components. As $n \geq 11$, there is a vertex d incident, in \mathcal{F} , to one of the vertices of the previous picture. By Lemmas 3.8 and 3.4, d must be incident to either $a, b,$ or c . If d were incident to one of the unlabelled vertices, then by Lemma 3.4, we could create another fracture graph where that unlabelled vertex had degree at least 4, contradicting Lemma 3.8. Suppose that d is incident to a and let l be the label of the edge $\{a, d\}$. Then l must be consecutive with both i and j and the degree of d must be 1 in \mathcal{G} , for otherwise we get another square with a vertex in a fifth component of \mathcal{F} , contradicting Lemma 3.2(2). Using the same arguments, we can conclude that d cannot be connected to b and that when d is connected to c we are in the same situation as in the case where d is connected to a . Hence, $n \leq 7 + 2 = 9$ and $r = n - 4$, a contradiction to the fact that $n \geq 3 + 2 \cdot 4 = 11$.

Case 2. $j = i + 1$ and $k \neq i + 2$. There are two alternating squares as in the figure below:

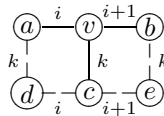

By Lemmas 3.4 and 3.8, v and c are both of degree 3 in \mathcal{G} . As we have three connected components at least, $l \geq 3$, and $n \geq 9$, either $a, b, d,$ or e is incident to another vertex. By Lemma 3.4 and the fact that i is smallest possible, we may consider that b is incident to a vertex f (not necessarily in \mathcal{F}). As v has degree 3, the label of $\{b, f\}$ must be $i + 2$. Indeed, if it were i , by Lemmas 3.4, 3.7, and 3.3, \mathcal{F} would have at least five connected components, a contradiction to Lemma 3.2(2). Now we consider separately the case $k \neq i + 3$ and $k = i + 3$.

Case 2.1. Suppose that $k \neq i + 3$. Then we are in one of the following two situations:

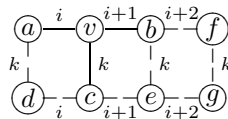

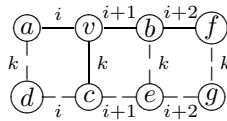

In the first case, $\{b, f\}$ is not in \mathcal{F} , by Lemmas 3.4, 3.7, and 3.3, and \mathcal{F} has at least five connected components, contradicting Lemma 3.2(2). Hence $\{b, f\}$ is in \mathcal{F} , and we are in the second case. Now the vertices $v, d, e,$ and g are in different components of \mathcal{F} , and the degree of b and e in \mathcal{G} is 3, by Lemmas 3.4 and 3.8. As $l \geq 4$, we have $n \geq 11$ and either $a, d, f,$ or g is incident, in \mathcal{F} , to another vertex. We may assume that f is incident to another vertex h in \mathcal{F} . Now the label of $\{f, h\}$ must be consecutive with both $i + 2$ and k . But then the degree of $a, d,$ and g is 2 in \mathcal{G} , and the degree of h is 1 in \mathcal{G} . Therefore $n = 9$, a contradiction.

Case 2.2. Suppose that $k = i + 3$. First consider that $\{b, f\}$ is not in \mathcal{F} . Then we already have four connected components for \mathcal{F} and $n \geq 11$. Moreover, f must be of degree 1 in \mathcal{G} . Thus e has to be connected to another vertex with an $(i + 2)$ -edge in \mathcal{F} . Then by Lemma 3.4, we may assume that $\{b, f\}$ is in \mathcal{F} and that \mathcal{F} has at least three components. Then $n \geq 3 + 2.3 = 9$; thus f must be incident with another vertex g :

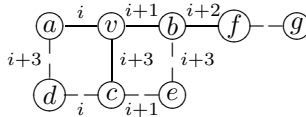

The label of the edge $\{f, g\}$ must be consecutive with $i + 2$; therefore the edge $\{f, g\}$ is not in \mathcal{F} . All vertices of the component of \mathcal{F} containing the vertex g have degree at most 2 and incident edges have consecutive labels. We get the possibility (B) given in this lemma.

Case 3. $j = i + 1$ and $k = i + 2$. We have one alternating square as in the following figure:

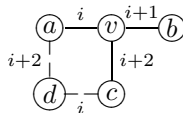

If the degree of a is greater than 1 in \mathcal{F} , then by Lemma 3.4 there exists a fracture graph with a vertex of degree 3 adjacent to edges with labels as in one of cases (1) or (2). Thus we assume that the degree of a is 1 in \mathcal{F} . By the same reasoning the degree of c in \mathcal{F} is 1 and d is an isolated vertex of \mathcal{F} , or else we can use Lemma 3.4 and revert to a previously solved case. The degree of b is 1 in \mathcal{F} , as another edge of \mathcal{F} incident with b would have a label not consecutive with $i + 1$, implying that v has degree 4 and contradicting Lemma 3.8. Hence, as \mathcal{F} has at least three components, $r \leq n - 3$.

Now suppose that there is another vertex of degree 3 in \mathcal{F} . In that case, \mathcal{F} has four components (and $n \geq 11$): two components with 4 vertices and 2 isolated vertices; hence $n = 4 + 4 + 1 + 1 = 10$, a contradiction. Thus only v has degree 3 in \mathcal{F} .

If $r = n - 3$, we get only one possibility for \mathcal{F} corresponding to graph (A).

If $r = n - 4$, \mathcal{F} has a component containing the vertex v of degree 3, a component that is an isolated vertex d , and another two components that have only vertices of

degree ≤ 2 . If a is incident to another vertex e in \mathcal{G} , then the label of $\{a, e\}$ must be consecutive with i by Lemma 3.8. If it is $i - 1$, then we have an alternating square with labels $i - 1$ and $i + 2$, as in the following figure:

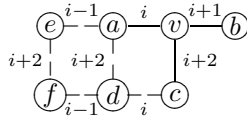

By Lemmas 3.7 and 3.3, $v, d, e,$ and f are in different components of \mathcal{F} . As $n > 7$ one of the vertices of the figure above is incident (in \mathcal{F}) to another vertex and we get a fifth connected component (as every time we create a square in the graph, we need one more component for the fracture graph) of \mathcal{F} , a contradiction. Hence the label of $\{a, e\}$ is $i + 1$. Similarly if c or d is incident to another vertex, the label of that edge must be $i + 1$. If two vertices of the set $\{a, c, d\}$ have degree 3 in \mathcal{G} , then we get two additional components that are isolated vertices. In that case, $n \leq 7$, a contradiction. Therefore, only one vertex of $\{a, c, d\}$ can have degree 3 in \mathcal{G} . If d has degree 3, then the vertex e incident to d must be an isolated vertex of \mathcal{F} . Moreover, either e or b has degree greater than 1 in \mathcal{G} (but not both). Thus we get two possibilities for \mathcal{F} : one corresponding to graph (C) of this lemma and the other is the following graph:

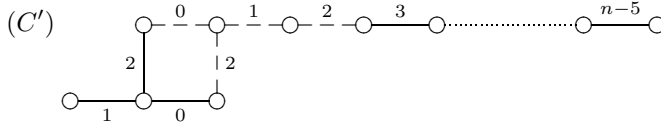

In (C') both 0-edges, 1-edges, and 2-edges are between vertices in different Γ_i -orbits ($i = 0, 1,$ or 2 respectively). Therefore if Γ admits the fracture graph C , it also admits the fracture graph C' and vice-versa; hence in this lemma only the possibility (C) needs to be listed. By the same reasoning, if a or c has degree 3, Γ has a fracture graph (D).

Now suppose that $a, c,$ and d have degree 2 in \mathcal{G} . Then b is incident to a vertex e in \mathcal{G} and the label of $\{b, e\}$ must be consecutive with $i + 1$. We may assume it is $i + 2$. The label of an edge incident with e must be consecutive with e , so e is either an isolated vertex of \mathcal{F} or has degree 1 in \mathcal{F} . Suppose that e is an isolated vertex of \mathcal{F} :

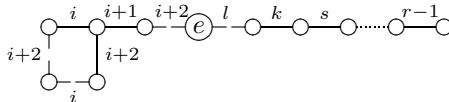

If $l = i + 1$, then $k \in \{i, i + 2\}$, which is not possible. Hence $l = i + 3, k = i + 4, s = i + 3$, but then $n = 9$, a contradiction. Thus e is not isolated. Suppose that the last component is an isolated vertex; then there is one possibility for \mathcal{F} , corresponding to graph (E).

Now suppose that \mathcal{F} has only one isolated vertex (the one in the square):

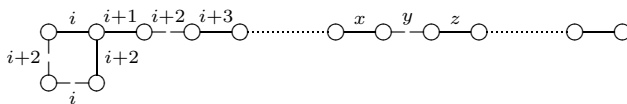

In that case, $y \in \{x-1, x+1\} \cap \{z-1, z+1\}$ and $x < z$ imply that $y = x+1 = z-1$. Hence $z = x + 2$, and the unique possibility for \mathcal{F} is graph (E') :

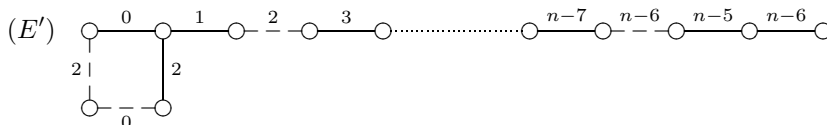

As the dashed edges are uniquely determined, if (E) is a fracture graph of Γ , then (E') is also a fracture graph of Γ and vice-versa, so only one of these two graphs needs to be listed in this lemma. \square

Lemma 3.10. *Let $x \in \{1, 2, 3, 4\}$ and let $n \geq 3 + 2x$ when $r = n - x$. If a fracture graph \mathcal{F} of Γ has adjacent edges with nonconsecutive labels, then Γ also has a fracture graph with a vertex of degree 3.*

Proof. Suppose that \mathcal{F} has two adjacent edges with nonconsecutive labels i and j and assume, by way of contradiction, that Γ has no fracture graph with a vertex of degree 3. The graph \mathcal{G} has an alternating square with labels i and j :

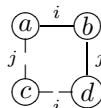

There exists no vertex incident, in \mathcal{F} , to one of the vertices of the alternating i, j square, for, otherwise, using Lemma 3.4, we could create a fracture graph for Γ with a vertex of degree 3. Thus \mathcal{F} has at least three components and $n \geq 9$. Hence there is a vertex e adjacent to one of the vertices of the square in \mathcal{G} . By Lemma 3.4 we may assume that there exists a k -edge $\{a, e\}$ not in \mathcal{F} :

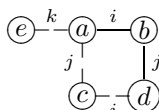

If k is not consecutive with both i and j , we have another two alternating squares and, by Lemmas 3.7 and 3.3, we get five connected components, contradicting Lemma 3.2(2). Thus k must be consecutive either with i or with j . Suppose that $k = i - 1$ and j is not consecutive with k . Then, by Lemmas 3.4 and 3.7, \mathcal{F} has four connected components. Therefore, b and d have degree 2 in \mathcal{G} . Now let e be incident to another vertex f and let l be the label of $\{e, f\}$. If l is not consecutive either with $i - 1$ or with j , using Lemmas 3.7 and 3.3, we get a fifth connected component, contradicting Lemma 3.2(2). Thus $j = i - 3$ and $l = i - 2$. Moreover the vertex g in the following figure must be isolated:

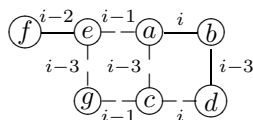

As $n \geq 11$, f must be $(i - 1)$ -incident to another vertex h , but then h cannot be incident to any other vertex; thus we get $n \leq 8$, a contradiction. Consequently the label k of an edge incident (in $\mathcal{G} \setminus \mathcal{F}$) to one of the vertices a, b, c , or d of the square must be consecutive with both i and j . Let $j = i + 2$ and $\{e, a\}$ be an $(i + 1)$ -edge

of $\mathcal{G} \setminus \mathcal{F}$. Suppose that e is l -adjacent to another vertex f in \mathcal{G} . The l must be consecutive with $i + 1$; thus $\{e, f\}$ is not in \mathcal{F} . Hence a is an isolated vertex of \mathcal{F} and \mathcal{F} has four components. Moreover any other vertex incident to the square must be an isolated vertex of \mathcal{F} ; thus we may assume that a is the unique vertex of the square having degree 3 in \mathcal{G} . Then either $l = i + 2$ or $l = i$, and then the other edge incident to f has label $i + 1$. This gives $n < 8$, a contradiction. \square

Lemma 3.11. *Let $x \in \{1, 2, 3, 4\}$ and let $n \geq 3 + 2x$ when $r = n - x$. Suppose that \mathcal{G} has adjacent edges with nonconsecutive labels but there is no fracture graph having adjacent edges with nonconsecutive labels. Then $r \in \{n - 4, n - 3\}$ and \mathcal{G} admits, up to a duality, a fracture graph \mathcal{F} of the following list:*

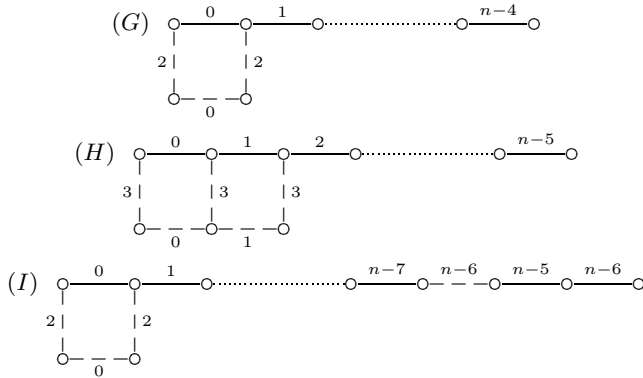

Proof. Let i and j be the labels of two adjacent edges in \mathcal{G} with $|i - j| > 1$. There is an alternating square in \mathcal{G} containing these edges. Let \mathcal{F} be a fracture graph of \mathcal{G} .

Suppose that the four vertices of the alternating square are in four different connected components of \mathcal{F} (which can happen only when $r = n - 4$). Consider a vertex k -incident to one of the vertices of the square. As \mathcal{F} has four connected components, this k -edge is an edge of \mathcal{F} . Suppose that k and j are not consecutive:

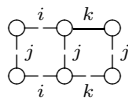

Then by Lemmas 3.7 and 3.3 we get five components of \mathcal{F} , a contradiction. Thus k must be consecutive with both i and j , and we have either that $k = i + 1$ and $j = i + 2$ or that $k = i - 1$ and $j = i - 2$. Therefore three components of \mathcal{F} are isolated vertices, and the component with more than one vertex must contain a $(k - 1)$ -edge and a $(k + 1)$ -edge simultaneously, which is not possible, as all incident edges of \mathcal{F} have consecutive labels.

Now suppose that a pair of vertices of the alternating square are in the same connected component of \mathcal{F} . Then by Lemma 3.5 one of the edges of the square is in \mathcal{F} . Suppose that one of the i -edges is in \mathcal{F} . Let $\{a, b\}$ be the i -edge of \mathcal{F} and let $\{v, w\}$ be the other i -edge of the alternating square. By Lemma 3.7, v , w , and a are in different connected components of \mathcal{F} . As before there is an edge incident to one of the vertices of the square. By Lemma 3.4 we may suppose that it connects b to some other vertex c .

Consider first the case $r = n - 3$. As \mathcal{F} has three connected components, c is in the same connected component as one of the vertices of the alternating square.

Hence by Lemmas 3.3 and 3.5, $\{b, c\}$ is the k -edge of \mathcal{F} :

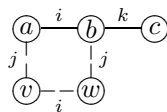

By the hypothesis that $r = n - 3$, we cannot create another connected component for \mathcal{F} , and therefore k must be consecutive with i . Suppose that k and j are not consecutive. Hence there is an alternating $\{k, j\}$ -square, and by Lemmas 3.6 and 3.3 we get a fourth component, which is not the case we are dealing with. Thus k is consecutive with both i and j . Therefore a has degree 1 in \mathcal{F} , and v and w are isolated vertices of \mathcal{F} . Then we get the graph (G) of this lemma.

Now let $r = n - 4$. First suppose that b and c are in different connected components of \mathcal{F} . Let k be the label of the edge $\{b, c\}$. Suppose that k is not consecutive with i . Then, by Lemma 3.7, we have a fifth connected component of \mathcal{F} , a contradiction. If k is not consecutive with j we have two alternating squares as in the following figure:

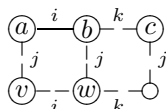

By Lemmas 3.7 and 3.3 either a k -edge or a j -edge is in \mathcal{F} . Then by Lemma 3.4 we get that either b and c are in the same connected component or that b and c are two nonconsecutive incident edges of \mathcal{F} , a contradiction. Hence k is consecutive with both i and j , and only the vertex b has degree greater than 2 in \mathcal{G} . All remaining incident edges must be consecutive:

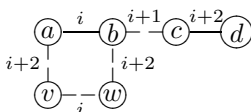

Now a vertex must be $(i + 1)$ -adjacent to one of the vertices a, v, w , or d . As there exists exactly one edge for each label and \mathcal{G} has exactly four components, we have that $n = 7$, a contradiction.

Consider that b and c are in the same connected component of \mathcal{F} . Then by Lemma 3.5 the k -edge $\{b, c\}$ is in \mathcal{F} . Moreover k must be consecutive with i , so let $k = i + 1$.

Suppose that k is not consecutive with j . Then we get two alternating squares as in the following figure:

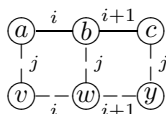

By Lemmas 3.7 and 3.3 the vertices a, v, w , and y are in different connected components of \mathcal{F} . There exists a vertex d incident to one of the vertices of the previous picture. The vertex d cannot be incident to either b or w ; otherwise we get two nonconsecutive incident edges of \mathcal{F} . By Lemma 3.4, we may assume d is incident with c . By hypothesis, the label of $\{c, d\}$ must now be $i + 2$. Hence $j = i + 3$, for, otherwise, we get a fifth component of \mathcal{F} . This gives fracture graph (H) .

Now suppose that k is consecutive with both i and j and that all the vertices of the alternating square, except b , have degree 2 in \mathcal{G} . Then \mathcal{F} is the graph (I) or is the graph (I') obtained from (I) by interchanging the edge of label $n - 6$ that is in \mathcal{F} and the edge of label $n - 6$ that is not in \mathcal{F} . Only one of these two graphs needs to be listed in this lemma. \square

The permutation graph \mathcal{G} of Γ is *linear* if adjacent edges of \mathcal{G} have consecutive labels. When \mathcal{G} is linear, it is possible to give an ordering to the connected components of \mathcal{F} . A component of \mathcal{F} is *big* if it has at least 4 vertices. We say that a fracture graph is *maximal with respect to a component* if that component cannot become bigger in any other fracture graph.

In the following graphs we sometimes have more than one possibility for the label of an edge. If that is the case we write all possibilities for the label of that edge separated by a vertical bar. If one of the possibilities is a double edge we write a set with two labels instead of a single label.

Proposition 3.12. *Let $x \in \{1, 2, 3, 4\}$ and let $n \geq 3 + 2x$ when $r = n - x$. Suppose that \mathcal{G} is linear and \mathcal{F} is a maximal fracture graph of \mathcal{G} with respect to the last big component. Consider two components of \mathcal{F} at distance one in \mathcal{G} as in the following figure:*

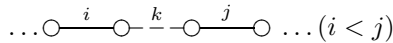

Then $k = i + 1$, $j = i + 2$, and \mathcal{F} has at least three components. Moreover, either the component containing the i -edge or the component containing the j -edge has exactly three vertices.

Proof. As \mathcal{G} is linear, $k \in \{i - 1, i + 1\} \cap \{j - 1, j + 1\}$ with $i < j$. Hence $k = i + 1$ and $j = i + 2$. As incident edges are consecutive, the edge with label $i + 1$ must belong to another component having exactly two vertices.

Let \mathcal{C} be the component of \mathcal{F} containing the $(i + 2)$ -edge. Suppose that the component consisting of a single $(i + 1)$ -edge is after \mathcal{C} .

First suppose that \mathcal{C} has more than 4 vertices. This forces \mathcal{F} to have at least five components, a contradiction. We show in the following figure what happens when \mathcal{C} has exactly 5 vertices:

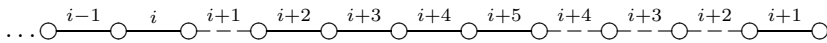

If \mathcal{C} has exactly 4 vertices, then \mathcal{F} has four components as in the following figure:

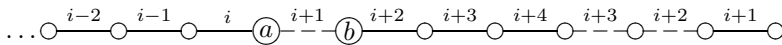

In this case \mathcal{F} has two big components, as $n \geq 11$. Consider the fracture graph \mathcal{F}' that we obtain by removing the $(i + 1)$ -edge of \mathcal{F} and replacing it by the $(i + 1)$ -edge $\{a, b\}$. The big component of \mathcal{F}' is bigger than the two big components of \mathcal{F} , contradicting the maximality of the big component of \mathcal{F} . The same argument can be used when \mathcal{C} has exactly three vertices.

Now suppose that \mathcal{C} has exactly 2 vertices. Then we have one of the following fracture graphs with four components:

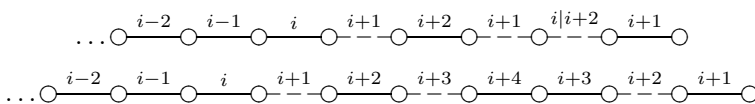

In any case, this contradicts the maximality of the (unique) big component of \mathcal{F} .

If the component being the $(i + 1)$ -edge is before \mathcal{C} we get the same contradiction to the maximality of the last big component (indeed maximality fails in all big components of \mathcal{F}). \square

Lemma 3.13. *Let $x \in \{1, 2, 3, 4\}$ and let $n \geq 3 + 2x$ when $r = n - x$. Suppose that \mathcal{G} is linear. Then \mathcal{G} is, up to duality, one of the following graphs, where $0 \leq i \leq r - 4$.*

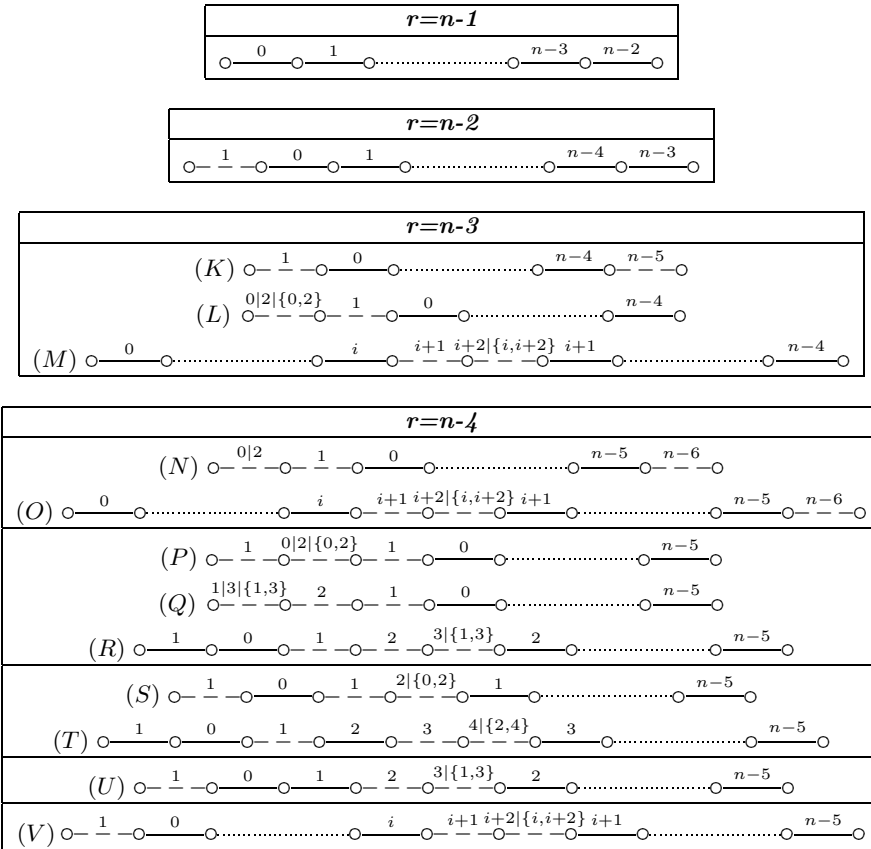

Proof. Let us assume that \mathcal{F} is maximal with respect to the last component.

To describe the sizes of the components of a fracture graph we use the following notation: B for big component, T for a component with 3 vertices, D for a component with 2 vertices, and O for an isolated vertex.

By Proposition 3.12 a component of \mathcal{F} that is at distance one of a big component in \mathcal{G} is either an isolated vertex or has 3 vertices. Therefore the number of big components is one or two (the last case being possible only when $r = n - 4$). Moreover, the last big component cannot be at distance one from a component with 3 vertices; otherwise we get a contradiction with the maximality of \mathcal{F} . We may assume that one of the last two components is big (for, otherwise, we may revert the ordering. For instance if we have the sequence $BDTT$ we can change to $TTDB$). There is only one possibility when $r = n - 1$ (only one component) and also only one possibility, up to duality, when $r = n - 2$ (one big component and an isolated vertex). For $r = n - 3$ we have the following 5 possibilities: OBO , OOB ,

DOB, TOB, and BOB. In the list given in this lemma the cases *DOB, TOB, and BOB* are put together as $i \geq 0$ can be small. Thus we have only 3 possible graphs when $r = n - 3$.

For $r = n - 4$, there are 10 possibilities for \mathcal{F} . We divide the table of all possibilities into five parts according to the 5 possibilities for the sizes of the last three components (the ones listed for $r = n - 3$).

In total we get 12 possibilities. Some cases have a parameter $i \geq 0$. In any case $r - i$ is the size of a big component; thus $r - i \geq 4$ or equivalently $i \leq r - 4$. \square

We now summarize in one single proposition the possibilities we obtained for \mathcal{G} in the previous lemmas.

Proposition 3.14. *Let $x \in \{1, 2, 3, 4\}$ and let $n \geq 3 + 2x$ when $r = n - x$. If Γ_j are intransitive for all $j \in \{0, \dots, r - 1\}$ and $r \geq n - 4$, then \mathcal{G} is, up to duality, one of the graphs given in Table 2, with $i \geq 0$ and $r - i \geq 4$.*

Proof. When \mathcal{G} is not linear we use Lemmas 3.9, 3.10, and 3.11. By Lemma 3.3 when \mathcal{G} has a fracture graph that is not linear we have that $\mathcal{G} = \mathcal{F}$. When all fracture graphs of Γ are linear but \mathcal{G} is not linear, we have the possibilities given by Lemma 3.11, and in that case the fracture graphs are proper subgraphs of \mathcal{G} . Indeed in all cases of Lemma 3.11 there is at least one vertical double edge; otherwise \mathcal{G} admits a fracture graph with a vertex of degree 3. By Lemma 3.3 only vertical edges can be added to those graphs. All the remaining graphs are linear, thus are given by Lemma 3.13. \square

4. THE INTERSECTION PROPERTY

In Proposition 3.14, 38 families of permutation representation graphs of rank $r \geq n - 4$ were constructed for sggis that are transitive permutation groups of degree n , and each permutation representation graph uniquely determines a group. In what follows we refer to those graphs by their label in Table 2. For each of these graphs we need to check which ones yield string C-groups, i.e., which corresponding groups satisfy the intersection property. The result of this process is the classification (up to isomorphism and duality) of all string C-groups of rank $r \geq n - 4$ obtained from a permutation group of degree n with only intransitive maximal parabolic subgroups. The proofs of many of the cases that yield string C-groups are similar, they are often inductive, and all make use of the following two lemmas.

Lemma 4.1 ([12]). *Let $\Gamma = \langle \rho_0, \dots, \rho_{r-1} \rangle$ be an sggi. If $\Gamma_0 := \langle \rho_1, \dots, \rho_{r-1} \rangle$ and $\Gamma_{r-1} := \langle \rho_0, \dots, \rho_{r-2} \rangle$ are string C-groups, $\rho_{r-1} \notin \Gamma_{r-1}$, and $\langle \rho_1, \dots, \rho_{r-2} \rangle$ is maximal in Γ_0 , then Γ is itself a string C-group.*

Lemma 4.2 ([13]). *If $\Gamma = \langle \rho_i \mid i = 0, \dots, r - 1 \rangle$ and $\Gamma^* = \langle \rho_i \tau^{\eta_i} \mid i \in \{0, \dots, r - 1\} \rangle$ is a sesqui-extension of Γ with respect to ρ_k , then:*

- (1) $\Gamma^* \cong \Gamma$ or $\Gamma^* \cong \Gamma \times \langle \tau \rangle \cong \Gamma \times C_2$.
- (2) If there is an element of Γ which is written with an odd number of ρ_k 's and is equal to the identity, then $\Gamma^* \cong \Gamma \times \langle \tau \rangle$.
- (3) If Γ is a permutation group, τ and ρ_k are odd permutations, and all other ρ_i are even permutations, then $\Gamma^* \cong \Gamma$.
- (4) Whenever $\tau \notin \Gamma^*$, Γ is a string C-group if and only if Γ^* is a string C-group.

TABLE 2. Possible CPR graphs of rank $\geq n - 4$ string C-groups.

(A)	(G)
(K)	(L1)
(L2)	(L3)
(M1)	(M2)
(B)	(C)
(D)	(E)
(H1)	(H2)
(I)	(N1)
(N2)	(N3)
(O1)	(O2)
(P1)	(P2)
(P3)	(Q1)
(Q2)	(Q3)
(R1)	(R2)
(S1)	(S2)
(T1)	(T2)
(U1)	(U2)
(V1)	(V2)

It is known that the ranks $n - 1$ and $n - 2$ of Table 2 yield string C-groups. We now deal with ranks $n - 3$ and $n - 4$ separately.

4.1. Rank $n - 3$. First let us consider the permutation representation graphs from the previous section which have rank $n - 3$ with $n \geq 9$.

Proposition 4.3. *None of the string groups generated by involutions Γ described by the permutation representation graphs (M1) or (M2, $i \geq 1$) are C-groups.*

Proof. Let us first consider the group $\Gamma := \langle \rho_0, \dots, \rho_{r-1} \rangle$ corresponding to the graph (M1). For this group consider the intersection $\Gamma_{\leq i+2}$ and $\Gamma_{\geq i+1}$. If the intersection condition held, then they would intersect in a dihedral group $\langle \rho_{i+1}, \rho_{i+2} \rangle$ of order 10 acting on the five points in the support of those two generators. However, $\Gamma_{\leq i+2}$ and $\Gamma_{\geq i+1}$ are both symmetric groups acting on $i+6$ points. This can be seen, for example, since both contain a transitive subgroup acting on $i+5$ points and a transposition acting on the remaining point. This implies that both groups contain the symmetric group acting on the five points in the support of $\langle \rho_{i+1}, \rho_{i+2} \rangle$. Therefore $\Gamma_{\leq i+2} \cap \Gamma_{\geq i+1} \cong S_5$, and thus Γ fails to satisfy the intersection property.

Now consider the group (M2) with $i \geq 1$. In this case we have $\Gamma_{\leq i+1} \cap \Gamma_{\geq i} \neq \Gamma_{i,i+1}$ by the same reasoning as before. Note that in the case $i = 0$ needs to be treated separately as $\Gamma_{\leq i+1}$ is not the symmetric group anymore. \square

Proposition 4.4. *The string group generated by involutions Γ , described by the permutation representation graph (L1), is a C-group.*

Proof. This follows directly from Theorem 3 of [11]. \square

Proposition 4.5. *The sggi Γ , described by the permutation representation graph (L2), is a C-group.*

Proof. We use Lemma 4.1 to show that Γ is a C-group. The group Γ_{r-1} is assumed to be a C-group by induction. The group Γ_0 is an intransitive group acting on two orbits, of sizes 3 and $n-3$, and thus is a subgroup of $S_3 \times S_{n-3}$. Furthermore, it contains a full symmetric group acting on the $n-3$ points in one orbit (as Γ acts transitively and contains a transposition on these $n-3$ points). The element $(\rho_2 \rho_3)^3$ acts trivially on this orbit and as a transposition on the smaller orbit. The element $(\rho_1 \rho_2 \rho_3)^4$ also acts trivially on the larger orbit and as a three-cycle on the smaller orbit. Thus $\Gamma_0 \cong S_3 \times S_{n-3}$.

To show that Γ_0 is a C-group, consider the groups $\Gamma_{0,1}$ and $\Gamma_{0,r-1}$. The group $\Gamma_{0,1}$ is a sesqui-extension of a simplex and thus, by Lemma 4.2, it is a string C-group isomorphic to $C_2 \times S_{n-4}$ (as $(\rho_2 \rho_3)^3$ acts trivially on the orbit with $n-4$ points). The group $\Gamma_{0,r-1}$ is a parabolic subgroup of Γ_{r-1} and thus is a C-group. The same arguments that gave the isomorphism type of Γ_0 show that $\Gamma_{0,r-1} \cong S_3 \times S_{n-4}$. Both $\Gamma_{0,r-1}$ and $\Gamma_{0,1}$ are thus C-groups, and $\Gamma_{0,1,r-1}$ can similarly be shown to be isomorphic to $C_2 \times S_{n-5}$ which is maximal in $\Gamma_{0,1}$. Therefore, Γ_0 is a C-group, and as $\Gamma_{0,r-1}$ is maximal in Γ_0 , Γ is a C-group. \square

Proposition 4.6. *The sggi Γ described by the permutation representation graph (L3) is a C-group.*

Proof. The groups Γ_0 and $\Gamma_{0,r-1}$ are the same as in Proposition 4.5, and thus Γ_0 is a C-group isomorphic to $S_3 \times S_{n-3}$, and $\Gamma_{0,r-1} \cong S_3 \times S_{n-4}$. The group Γ_{r-1} is assumed to be a C-group by induction. As $\Gamma_{0,r-1}$ is maximal in Γ_0 , the group Γ is a C-group by Lemma 4.1. \square

Proposition 4.7. *The sggi Γ , described by the permutation representation graph (M2, $i = 0$), is a C-group.*

Proof. The group Γ_0 is shown to be a C-group isomorphic to S_{n-1} in Lemma 21 of [11]. The group Γ_{r-1} is assumed to be a string C-group by induction. Finally, the group $\Gamma_{0,r-1}$ is isomorphic to S_{n-2} and thus is maximal in Γ_0 . Hence, by Lemma 4.1, Γ is a string C-group. \square

Proposition 4.8. *The sggi Γ described by the permutation representation graph (A) is a string C-group.*

Proof. The group Γ_0 is a sesqui-extension of a group which is a string C-group by Lemma 21 of [11] and Lemma 4.2 and thus is itself a C-group. Furthermore, the element $(\rho_2\rho_1\rho_2\rho_3\rho_2)^5$ acts as the identity on the larger orbit of Γ_0 and as a transposition on the smaller orbit. Therefore $\Gamma_0 \cong C_2 \times S_{n-2}$; similarly, $\Gamma_{0,r-1} \cong C_2 \times S_{n-3}$. The group Γ_{r-1} is assumed to be a C-group by induction. Therefore, since $\Gamma_{0,r-1}$ is maximal in Γ_0 , Γ is a string C-group. \square

Proposition 4.9. *The sggi Γ , described by the permutation representation graph (G), is a C-group.*

Proof. The group Γ_0 is an intransitive group acting on two orbits of sizes 2 and $n-2$. Furthermore, it contains a full symmetric group acting on the larger orbit. The element $(\rho_2\rho_1\rho_2\rho_3)^3$ acts as the identity on the larger orbit and as a transposition on the smaller one. Thus $\Gamma_0 \cong C_2 \times S_{n-2}$; similarly, $\Gamma_{0,r-1} \cong C_2 \times S_{n-3}$. The group $\Gamma_{0,1}$ is a sesqui-extension of the simplex and thus is a C-group isomorphic to $C_2 \times S_{n-4}$; similarly, $\Gamma_{0,1,r-1} \cong C_2 \times S_{n-5}$. We assume that Γ_{r-1} is a C-group by induction, and thus $\Gamma_{0,r-1}$ is also a C-group. Since both $\Gamma_{0,1}$ and $\Gamma_{0,r-1}$ are C-groups and $\Gamma_{0,1,r-1}$ is maximal in $\Gamma_{0,1}$, the group Γ_0 is a C-group. Now as both Γ_0 and Γ_{r-1} are C-groups and $\Gamma_{0,r-1}$ is maximal in Γ_0 , we conclude that Γ is a string C-group. \square

Proposition 4.10. *The sggi Γ , described by the permutation representation graph (K), is a C-group.*

Proof. The groups Γ_0 and Γ_{r-1} are both sesqui-extensions of a group which is a string C-group by Lemma 21 of [11] and thus are themselves C-groups. Furthermore they are both isomorphic to $C_2 \times S_{n-2}$. As $\Gamma_{0,r-1} \cong C_2 \times S_{n-4} \times C_2$ is maximal in Γ_0 , the group Γ is a string C-group. \square

Note that all groups corresponding to the graphs of Table 2 are transitive and contain a transposition. Thus they are isomorphic to S_n . In Propositions 4.3 through 4.10 we proved that seven graphs, namely (A), (G), (K), (L1), (L2), (L3), and M2 (with $i = 0$), correspond to rank $n - 3$ string C-groups isomorphic to S_n for $n \geq 9$. So far we have shown that this is the complete list of rank $n - 3$ transitive string C-groups with connected diagram when all maximal parabolic subgroups are intransitive. Let us now consider the rank $n - 4$ case.

4.2. Rank $n - 4$. To show which rank $n - 4$ groups do not satisfy the intersection property, we could proceed in the manner above, dealing with each rank $n - 4$ group ad hoc. However, for the sake of brevity, we utilize the fact that all the proofs that confirm the actual string C-groups are inductive, with the base case (where $n = 11$) checked using MAGMA [1]. Thus, we also use MAGMA to simplify many of the proofs showing which remaining permutation representation graphs do not yield string C-groups. In order to do this, we notice that for many of the groups, the base case (where $n = 11$) gives a parabolic subgroup of the larger, higher rank cases. Thus simply knowing that the case where $n = 11$ does not yield a string C-group proves that many of the groups in question are not string C-groups for any $n \geq 11$. We point out here that although the computer is used to shorten this article, each of the cases can be easily done by hand as well.

Proposition 4.11. *None of the string groups generated by involutions Γ , described by the permutation representation graphs (C) , (D) , $(H1)$, $(H2)$, $(P2)$, $(P3)$, $(Q1)$, $(Q3)$, $(R1)$, $(R2)$, $(S1)$, $(S2)$, $(T1)$, $(T2)$, $(U1)$, or $(U2)$, are C-groups.*

Proof. It can easily be verified using MAGMA that when $n = 11$ none of these graphs yield a string C-group. For larger n , let $\Gamma = \langle \rho_0, \dots, \rho_{n-5} \rangle$ be the group corresponding to the permutation representation graph on n points. Now consider the group $\Gamma_{\leq 6}$. This group is exactly one of the groups shown to not satisfy the intersection by MAGMA above. Thus, since $\Gamma_{\leq 6}$ is not a string C-group, neither is Γ . □

Next let us consider the groups given by graphs $(O1)$, $(O2)$, $(V1)$, and $(V2)$. These cannot be treated as above, as they each represent a family of groups not only indexed by n but also by i .

Proposition 4.12. *None of the string groups generated by involutions Γ , described by the permutation representation graphs $(O1)$, $(O2, i \geq 1)$, $(V1)$, or $(V2)$, are C-groups.*

Proof. Observe that the graphs $(V2)$ with $i = 0$ and $(S2)$ are the same and that the graphs $(V2)$ with $i = 1$ and $(R2)$ are also the same. For the remaining cases, the proof of this is the same as the proof of Proposition 4.3. □

Proposition 4.13. *The sggi Γ , described by the permutation representation graph (B) , is a C-group.*

Proof. We use Lemmas 4.1 and 4.2 to show that Γ is a C-group. The group Γ_{r-1} is assumed to be a C-group by induction. To show that Γ_0 is a C-group, we consider the groups $\Gamma_{0,1}$, $\Gamma_{0,1,2}$, $\Gamma_{0,r-1}$, $\Gamma_{0,1,r-1}$, and $\Gamma_{0,1,2,r-1}$. The groups $\Gamma_{0,1,2}$ and $\Gamma_{0,1,2,r-1}$ are sesqui-extensions of a simplex and thus, by Lemma 4.2, are both string C-groups isomorphic to $C_2 \times S_{n-6}$ and $C_2 \times S_{n-7}$ respectively. Note also that $\Gamma_{0,r-1}$ and $\Gamma_{0,1,r-1}$ are string C-groups as they are parabolic subgroups of Γ_{r-1} . By Lemma 4.1, since $\Gamma_{0,1,2,r-1}$ is maximal in $\Gamma_{0,1,2}$ and both $\Gamma_{0,1,2}$ and $\Gamma_{0,1,r-1}$ are string C-groups, we conclude that $\Gamma_{0,1}$ is also a string C-group.

The group $\Gamma_{0,1}$ is a sesqui-extension of a string C-group isomorphic to S_{n-4} (see [11]). Furthermore, the element $(\rho_3\rho_2\rho_3\rho_4\rho_3)^5$ acts as identity on the orbit of size $n - 4$ and thus $\Gamma_{0,1} \cong C_2 \times S_{n-4}$. Similarly $\Gamma_{0,1,r-1} \cong C_2 \times S_{n-5}$. Since both $\Gamma_{0,1}$ and $\Gamma_{0,r-1}$ are string C-groups and $\Gamma_{0,1,r-1}$ is maximal in $\Gamma_{0,1}$, we conclude that Γ_0 is a string C-group.

Finally, the groups Γ_0 and $\Gamma_{0,r-1}$ are sesqui-extensions of string C-groups isomorphic to S_{n-2} (see (A) in Table 2) and S_{n-3} , respectively. Furthermore, the element $(\rho_1\rho_2\rho_3\rho_2\rho_3\rho_4\rho_3)^7$ acts trivially on the larger orbit and as a transposition on the smaller orbit. Thus $\Gamma_0 \cong C_2 \times S_{n-2}$ and $\Gamma_{0,r-1} \cong C_2 \times S_{n-3}$. Since both Γ_0 and Γ_{r-1} are string C-groups and $\Gamma_{0,r-1}$ is maximal in Γ_0 , we conclude that Γ is a string C-group. □

Proposition 4.14. *The sggi Γ , described by the permutation representation graph (E) , is a C-group.*

Proof. To show that Γ is a C-group, we consider the groups Γ_0 , Γ_{r-1} , $\Gamma_{0,1}$, $\Gamma_{0,r-1}$, and $\Gamma_{0,1,r-1}$. The group Γ_{r-1} is a sesqui-extension of a string C-group isomorphic to S_{n-2} (see (A) in Table 2) and thus is itself a string C-group by Lemma 4.2. Furthermore, the element $(\rho_{r-2}\rho_{r-3})^3$ acts as identity on the larger orbit of Γ_{r-1}

and thus $\Gamma_{r-1} \cong S_{n-2} \times C_2$. The group $\Gamma_{0,1}$ is a sesqui-extension of a string C-group isomorphic to S_{n-2} (see [11]) and is thus a string C-group. Furthermore, the element $(\rho_2\rho_3)^3$ acts trivially on the larger orbit of $\Gamma_{0,1}$ and thus $\Gamma_{0,1} \cong S_{n-4} \times C_2$. Similarly, $\Gamma_{0,1,r-1} \cong S_{n-6} \times C_2 \times C_2$, which is maximal in $\Gamma_{0,1}$. The group $\Gamma_{0,r-1}$ is also a string C-group as it is a parabolic subgroup of Γ_{r-1} , and thus by Lemma 4.1, Γ_0 is a string C-group. The element $(\rho_2\rho_1\rho_2\rho_3\rho_2)^5$ acts trivially on the larger orbit of Γ_0 and thus $\Gamma_0 \cong S_{n-2} \times C_2$, and similarly $\Gamma_{0,r-1} \cong S_{n-4} \times C_2 \times C_2$, which is maximal in Γ_0 . Since both Γ_0 and Γ_{r-1} are string C-groups and $\Gamma_{0,r-1}$ is maximal in Γ_0 , by Lemma 4.1, Γ is a string C-group. \square

Proposition 4.15. *The sggi Γ , described by the permutation representation graph (I2), is a C-group.*

Proof. To show that Γ is a C-group, we consider the groups $\Gamma_0, \Gamma_{r-1}, \Gamma_{0,1}, \Gamma_{0,r-1}$, and $\Gamma_{0,1,r-1}$. The group Γ_{r-1} is a sesqui-extension of a string C-group isomorphic to S_{n-2} (see (G) in Table 2) and thus is itself a string C-group by Lemma 4.2. Furthermore, the element $(\rho_{r-2}\rho_{r-3})^3$ acts as identity on the larger orbit of Γ_{r-1} and thus $\Gamma_{r-1} \cong S_{n-2} \times C_2$. The group $\Gamma_{0,1}$ is a sesqui-extension of a string C-group isomorphic to S_{n-2} (see [11]) and is thus a string C-group. Furthermore, the element $(\rho_2\rho_3)^3$ acts trivially on the larger orbit of $\Gamma_{0,1}$ and thus $\Gamma_{0,1} \cong S_{n-4} \times C_2$. Similarly, $\Gamma_{0,1,r-1} \cong S_{n-6} \times C_2 \times C_2$, which is maximal in $\Gamma_{0,1}$. The group $\Gamma_{0,r-1}$ is also a string C-group as it is a parabolic subgroup of Γ_{r-1} , and thus by Lemma 4.1, Γ_0 is a string C-group. The element $(\rho_2\rho_1\rho_2\rho_3\rho_4\rho_3)^3$ acts trivially on the larger orbit of Γ_0 and thus $\Gamma_0 \cong S_{n-2} \times C_2$, and similarly $\Gamma_{0,r-1} \cong S_{n-4} \times C_2 \times C_2$, which is maximal in Γ_0 . Since both Γ_0 and Γ_{r-1} are string C-groups and $\Gamma_{0,r-1}$ is maximal in Γ_0 , by Lemma 4.1, Γ is a string C-group. \square

Proposition 4.16. *The sggi Γ , described by the permutation representation graph (N1), is a C-group.*

Proof. To show that Γ is a C-group, we consider the groups Γ_0, Γ_{r-1} , and $\Gamma_{0,r-1}$. The groups Γ_0 and Γ_{r-1} are both sesqui-extensions of string C-groups which are isomorphic to S_{n-3} and S_{n-2} respectively (see [11]), and thus are themselves string C-groups by Lemma 4.2. Furthermore, the element $(\rho_{r-2}\rho_{r-3})^3$ acts as identity on the larger orbit of Γ_{r-1} and thus $\Gamma_{r-1} \cong S_{n-2} \times C_2$. Similarly $(\rho_1\rho_2)^3$ acts as identity on the larger orbit of Γ_0 and thus $\Gamma_0 \cong S_{n-3} \times C_2$ and $\Gamma_{0,r-1} \cong S_{n-5} \times C_2 \times C_2$. Since both Γ_0 and Γ_{r-1} are string C-groups and $\Gamma_{0,r-1}$ is maximal in Γ_0 , by Lemma 4.1, Γ is a string C-group. \square

Proposition 4.17. *The sggi Γ , described by the permutation representation graph (N2), is a C-group.*

Proof. To show that Γ is a C-group, we consider the groups $\Gamma_0, \Gamma_{r-1}, \Gamma_{0,1}, \Gamma_{0,r-1}$, and $\Gamma_{0,1,r-1}$. The group Γ_{r-1} is a sesqui-extension of a string C-group isomorphic to S_{n-2} (see (L2) in Table 2) and thus is itself a string C-group by Lemma 4.2. Furthermore, the element $(\rho_{r-2}\rho_{r-3})^3$ acts as identity on the larger orbit of Γ_{r-1} and thus $\Gamma_{r-1} \cong S_{n-2} \times C_2$. The group $\Gamma_{0,1}$ is a sesqui-extension of a string C-group isomorphic to S_{n-2} (see [11]) and is thus a string C-group. Furthermore, the element $(\rho_2\rho_3)^3$ acts trivially on the larger orbit of $\Gamma_{0,1}$ and thus $\Gamma_{0,1} \cong S_{n-4} \times C_2$. Similarly, $\Gamma_{0,1,r-1} \cong S_{n-6} \times C_2 \times C_2$, which is maximal in $\Gamma_{0,1}$. The group $\Gamma_{0,r-1}$ is also a string C-group as it is a parabolic subgroup of Γ_{r-1} , and thus by Lemma 4.1, Γ_0 is a string C-group. Similarly to the proof of Proposition 4.5, it can be shown

that $\Gamma_0 \cong S_{n-3} \times S_3$, and similarly $\Gamma_{0,r-1} \cong S_{n-5} \times S_3 \times C_2$, which is maximal in Γ_0 . Since both Γ_0 and Γ_{r-1} are string C-groups and $\Gamma_{0,r-1}$ is maximal in Γ_0 , by Lemma 4.1, Γ is a string C-group. \square

Proposition 4.18. *The sggi Γ , described by the permutation representation graph (N3), is a C-group.*

Proof. To show that Γ is a C-group, we consider the groups Γ_0, Γ_{r-1} , and $\Gamma_{0,r-1}$. The group Γ_0 was shown to be a string C-group isomorphic to $S_3 \times S_{n-3}$ in the previous lemma. The group Γ_{r-1} is a sesqui-extension of a string C-group isomorphic to S_{n-2} (see (L3) in Table 2) and thus is itself a string C-group by Lemma 4.2. Furthermore, the element $(\rho_{r-2}\rho_{r-3})^3$ acts as identity on the larger orbit of Γ_{r-1} , and thus $\Gamma_{r-1} \cong S_{n-2} \times C_2$ and $\Gamma_{0,r-1} \cong S_3 \times S_{n-5} \times C_2$. Since both Γ_0 and Γ_{r-1} are string C-groups and $\Gamma_{0,r-1}$ is maximal in Γ_0 , by Lemma 4.1, Γ is a string C-group. \square

Proposition 4.19. *The sggi Γ , described by the permutation representation graph (O2, $i = 0$), is a C-group.*

Proof. To show that Γ is a C-group, we consider the groups Γ_0, Γ_{r-1} , and $\Gamma_{0,r-1}$. The group Γ_{r-1} is a sesqui-extension of a string C-group which is isomorphic to S_{n-2} (see (M2, $i = 0$) in Table 2) and thus is itself a string C-group by Lemma 4.2. Furthermore, the element $(\rho_{r-2}\rho_{r-3})^3$ acts as identity on the larger orbit of Γ_{r-1} and thus $\Gamma_{r-1} \cong S_{n-2} \times C_2$. Similarly, $\Gamma_{0,r-1} \cong S_{n-3} \times C_2$. The group Γ_0 is a string C-group isomorphic to S_{n-1} (see (N1) in Table 2). Since both Γ_0 and Γ_{r-1} are string C-groups and $\Gamma_{0,r-1}$ is maximal in Γ_0 , by Lemma 4.1, Γ is a string C-group. \square

Proposition 4.20. *The sggi Γ , described by the permutation representation graph (P1), is a C-group.*

Proof. To show that Γ is a C-group, we consider the groups Γ_0, Γ_{r-1} , and $\Gamma_{0,r-1}$. The group Γ_0 is a sesqui-extension of the rank $n - 5$ simplex acting on $n - 4$ points and thus is a string C-group by Lemma 4.2. Furthermore, the element $(\rho_{r-2}\rho_{r-3})^3$ acts as identity on the larger orbit of Γ_0 and thus $\Gamma_0 \cong S_{n-4} \times C_2$. Similarly, $\Gamma_{0,r-1} \cong S_{n-5} \times C_2$. The group Γ_{r-1} is assumed to be a C-group by induction (as it too is of type (P1)). Since both Γ_0 and Γ_{r-1} are string C-groups and $\Gamma_{0,r-1}$ is maximal in Γ_0 , by Lemma 4.1, Γ is a string C-group. \square

Proposition 4.21. *The sggi Γ , described by the permutation representation graph (Q2), is a C-group.*

Proof. To show that Γ is a C-group, we consider the groups $\Gamma_0, \Gamma_{r-1}, \Gamma_{0,1}, \Gamma_{0,r-1}$, and $\Gamma_{0,1,r-1}$.

The group Γ_{r-1} is assumed to be a string C-group isomorphic to S_{n-1} by induction. The group $\Gamma_{0,1}$ was shown to be a C-group isomorphic to $S_{n-4} \times S_3$ in the proof of Proposition 4.5. Similarly, $\Gamma_{0,1,r-1} \cong S_{n-5} \times S_3$, which is maximal in $\Gamma_{0,1}$. The group $\Gamma_{0,r-1}$ is also a string C-group as it is a parabolic subgroup of Γ_{r-1} , and thus by Lemma 4.1, Γ_0 is a string C-group.

The group Γ_0 is an intransitive group acting on two orbits, of size 4 and $n - 4$, and thus is a subgroup of $S_4 \times S_{n-4}$. Furthermore, it contains a full symmetric group acting on the $n - 4$ points in one orbit. The element $\tau_1 := (\rho_2\rho_3\rho_4)^4$ acts trivially on this orbit and as a three-cycle on the smaller orbit. The element $\tau_2 := (\rho_1\rho_2\rho_3\rho_4)^5$

TABLE 3. Examples of transitive imprimitive string C-groups of degree n and rank $n/2 + 1$ for $n \leq 9$.

Degree	Number	Structure	Order	Schläfli type
6	9	$S_3 \times S_3$	36	[3, 2, 3]
6	11	$2^3 : S_3$	48	[2, 3, 3]
6	11	$2^3 : S_3$	48	[2, 3, 4]
8	45	$2^4 : S_3 : S_3$	576	[3, 4, 4, 3]

also acts trivially on the larger orbit and as a four-cycle on the smaller orbit. Thus $\langle \tau_1, \tau_2 \rangle \cong S_4$, and therefore $\Gamma_0 \cong S_4 \times S_{n-4}$. A similar argument shows that $\Gamma_{0,r-1} \cong S_4 \times S_{n-5}$, which is maximal in Γ_0 . Since both Γ_0 and Γ_{r-1} are string C-groups and $\Gamma_{0,r-1}$ is maximal in Γ_0 , by Lemma 4.1, Γ is a string C-group. \square

In Propositions 4.11 through 4.21 we proved that nine graphs, namely (B), (E), (I), (N1), (N2), (N3), (O2) (with $i = 0$), (P1), and (Q2), correspond to rank $n - 4$ string C-groups isomorphic to S_n for $n \geq 11$. So far we have shown that this is the complete list of rank $n - 4$ transitive string C-groups with connected diagram when all maximal parabolic subgroups are intransitive.

5. TRANSITIVE PERMUTATION GROUPS

In this section, we prove that, under the hypotheses of Theorem 1.1, all the maximal parabolic subgroups must be intransitive. This permits us to conclude the proof of Theorem 1.1. We use the following result, due to Peter J. Cameron and the authors.

Theorem 5.1 ([5]). *Let Γ be a string C-group of rank r which is isomorphic to a transitive subgroup of S_n other than S_n or A_n . Then one of the following holds:*

- (1) $r \leq n/2$.
- (2) $n \equiv 2 \pmod 4$, $r = n/2 + 1$, and Γ is $C_2 \wr S_{n/2}$.
- (3) Γ is transitive imprimitive and is one of the examples appearing in Table 3.
- (4) Γ is primitive. In this case, Γ is obtained from the permutation representation of degree 6 of $S_5 \cong PGL_2(5)$, and it is the 4-simplex of Schläfli type [3, 3, 3].

Corollary 5.2. *Let $x \in \{1, 2, 3, 4\}$ and let $n \geq 3 + 2x$ when $r = n - x$. Let Γ be a rank r string C-group with connected diagram and isomorphic to a transitive permutation group of degree n . Then Γ_i is an intransitive group for each $i = 0, \dots, r - 1$.*

Proof. Suppose there exists $i \in \{0, \dots, r - 1\}$ such that Γ_i is transitive, and let us show that each of the four cases of Theorem 5.1 leads to a contradiction. As $r = n - x$, we have $r \geq \frac{n+3}{2}$ and therefore the rank of Γ_i , which is $r - 1 \geq (n + 1)/2 > n/2$. Hence Γ_i cannot belong to case (1) of Theorem 5.1. If we are in case (2) of Theorem 5.1, $r - 1 = n/2 + 1 = n - x - 1$ implies that $n = 2(x + 2)$ and therefore $n \in \{6, 8, 10, 12\}$. But $n \equiv 2 \pmod 4$ in case (2). Hence $n = 6$ or $n = 10$ in that case. Cases (3) and (4) imply that $n = 6$ or $n = 8$. So for one of cases (2), (3), or (4) to happen, we need $n = 6, 8$, or 10 . It is easily checked with MAGMA that all transitive groups of degree 6 (resp. 8), not isomorphic to a symmetric or an

alternating group have no string C-group representation of rank at least 4 (resp. 6). So only the case $n = 10$ remains.

When $n = 10$, we are in case (2) of Theorem 5.1 and $r - 1 = n - 4 = n/2 + 1$. Thus, there could exist a string C-group of rank 7 and degree 10 having a maximal parabolic subgroup that is transitive. If that is the case, Γ is a transitive group having a subgroup Γ_i of order 3840 as the group of case (2) in Theorem 5.1 is $C_2 \wr S_5$. There are 45 transitive groups of degree 10 and only two of them, namely S_{10} and A_{10} , may contain subgroups of order 3840. The alternating group is excluded as the first generator of Γ_i is composed of five transpositions and hence is an odd permutation. Only S_{10} remains. All string C-group representations of rank 7 of S_{10} can be easily computed with MAGMA and checked not to have any maximal parabolic subgroup that is transitive, ruling out the case $n = 10$. \square

ACKNOWLEDGMENT

The authors thank a referee for very useful comments on a preliminary version of this paper. This work was partially supported by a Marsden grant (UOA1218) from the Royal Society of New Zealand when the second listed author was based at the University of Auckland. It was also supported by the Portuguese Foundation for Science and Technology (FCT-Fundação para a Ciência e a Tecnologia), through CIDMA - Center for Research and Development in Mathematics and Applications, within project UID/MAT/04106/2013.

REFERENCES

- [1] Wieb Bosma, John Cannon, and Catherine Playoust, *The Magma algebra system. I. The user language*, Computational algebra and number theory (London, 1993), J. Symbolic Comput. **24** (1997), no. 3-4, 235–265, DOI 10.1006/jscs.1996.0125. MR1484478
- [2] Peter A. Brooksbank and Deborah A. Vicinsky, *Three-dimensional classical groups acting on polytopes*, Discrete Comput. Geom. **44** (2010), no. 3, 654–659, DOI 10.1007/s00454-009-9212-0. MR2679061
- [3] Francis Buekenhout and Dimitri Leemans, *On the list of finite primitive permutation groups of degree ≤ 50* , J. Symbolic Comput. **22** (1996), no. 2, 215–225, DOI 10.1006/jscs.1996.0049. MR1422147
- [4] Peter J. Cameron and Philippe Cara, *Independent generating sets and geometries for symmetric groups*, J. Algebra **258** (2002), no. 2, 641–650, DOI 10.1016/S0021-8693(02)00550-1. MR1943939
- [5] Peter J. Cameron, Maria Elisa Fernandes, Dimitri Leemans, and Mark Mixer, *String C-groups as transitive subgroups of S_n* , J. Algebra **447** (2016), 468–478, DOI 10.1016/j.jalgebra.2015.09.040. MR3427645
- [6] Peter J. Cameron, Maria Elisa Fernandes, Dimitri Leemans, and Mark Mixer, *Highest rank of a polytope for A_n* , Proc. Lond. Math. Soc. (3) **115** (2017), no. 1, 135–176, DOI 10.1112/plms.12039. MR3669935
- [7] Marston Conder, *The smallest regular polytopes of given rank*, Adv. Math. **236** (2013), 92–110, DOI 10.1016/j.aim.2012.12.015. MR3019717
- [8] Thomas Connor, Julie De Saedeleer, and Dimitri Leemans, *Almost simple groups with socle $\text{PSL}(2, q)$ acting on abstract regular polytopes*, J. Algebra **423** (2015), 550–558, DOI 10.1016/j.jalgebra.2014.10.020. MR3283730
- [9] Thomas Connor, Dimitri Leemans, and Mark Mixer, *Abstract regular polytopes for the O’Nan group*, Internat. J. Algebra Comput. **24** (2014), no. 1, 59–68, DOI 10.1142/S0218196714500052. MR3189666
- [10] John D. Dixon and Brian Mortimer, *Permutation groups*, Graduate Texts in Mathematics, vol. 163, Springer-Verlag, New York, 1996. MR1409812
- [11] Maria Elisa Fernandes and Dimitri Leemans, *Polytopes of high rank for the symmetric groups*, Adv. Math. **228** (2011), no. 6, 3207–3222, DOI 10.1016/j.aim.2011.08.006. MR2844941

- [12] Maria Elisa Fernandes, Dimitri Leemans, and Mark Mixer, *Polytopes of high rank for the alternating groups*, J. Combin. Theory Ser. A **119** (2012), no. 1, 42–56, DOI 10.1016/j.jcta.2011.07.006. MR2844081
- [13] Maria Elisa Fernandes, Dimitri Leemans, and Mark Mixer, *All alternating groups A_n with $n \geq 12$ have polytopes of rank $\lfloor \frac{n-1}{2} \rfloor$* , SIAM J. Discrete Math. **26** (2012), no. 2, 482–498, DOI 10.1137/110838467. MR2967478
- [14] Maria Elisa Fernandes, Dimitri Leemans, and Mark Mixer, *Corrigendum to “Polytopes of high rank for the symmetric groups” [Adv. Math. 228 (2011) 3207–3222] [MR2844941]*, Adv. Math. **238** (2013), 506–508, DOI 10.1016/j.aim.2012.10.006. MR3033641
- [15] Michael I. Hartley, *An atlas of small regular abstract polytopes*, Period. Math. Hungar. **53** (2006), no. 1-2, 149–156, DOI 10.1007/s10998-006-0028-x. MR2286467
- [16] Michael I. Hartley and Alexander Hulpke, *Polytopes derived from sporadic simple groups*, Contrib. Discrete Math. **5** (2010), no. 2, 106–118. MR2791293
- [17] Ann Kiefer and Dimitri Leemans, *On the number of abstract regular polytopes whose automorphism group is a Suzuki simple group $Sz(q)$* , J. Combin. Theory Ser. A **117** (2010), no. 8, 1248–1257, DOI 10.1016/j.jcta.2010.01.001. MR2677688
- [18] Dimitri Leemans, *Almost simple groups of Suzuki type acting on polytopes*, Proc. Amer. Math. Soc. **134** (2006), no. 12, 3649–3651, DOI 10.1090/S0002-9939-06-08448-6. MR2240679
- [19] Dimitri Leemans and Mark Mixer, *Algorithms for classifying regular polytopes with a fixed automorphism group*, Contrib. Discrete Math. **7** (2012), no. 2, 105–118. MR3011579
- [20] Dimitri Leemans and Egon Schulte, *Groups of type $L_2(q)$ acting on polytopes*, Adv. Geom. **7** (2007), no. 4, 529–539, DOI 10.1515/ADVGEOM.2007.031. MR2360900
- [21] Dimitri Leemans and Egon Schulte, *Polytopes with groups of type $PGL_2(q)$* , Ars Math. Contemp. **2** (2009), no. 2, 163–171. MR2550963
- [22] Dimitri Leemans, Egon Schulte, and Hendrik Van Maldeghem, *Groups of Ree type in characteristic 3 acting on polytopes*, Ars Math. Contemp. **14** (2018), 209–226.
- [23] Dimitri Leemans and Laurence Vauthier, *An atlas of abstract regular polytopes for small groups*, Aequationes Math. **72** (2006), no. 3, 313–320, DOI 10.1007/s00010-006-2843-9. MR2282877
- [24] Attila Maróti, *On the orders of primitive groups*, J. Algebra **258** (2002), no. 2, 631–640, DOI 10.1016/S0021-8693(02)00646-4. MR1943938
- [25] Peter McMullen and Egon Schulte, *Abstract regular polytopes*, Encyclopedia of Mathematics and its Applications, vol. 92, Cambridge University Press, Cambridge, 2002. MR1965665
- [26] Daniel Pellicer, *CPR graphs and regular polytopes*, European J. Combin. **29** (2008), no. 1, 59–71, DOI 10.1016/j.ejc.2007.01.001. MR2368614
- [27] Julius Whiston, *Maximal independent generating sets of the symmetric group*, J. Algebra **232** (2000), no. 1, 255–268, DOI 10.1006/jabr.2000.8399. MR1783924
- [28] Helmut Wielandt, *Finite permutation groups*, translated from the German by R. Bercov, Academic Press, New York-London, 1964. MR0183775

CENTER FOR RESEARCH AND DEVELOPMENT IN MATHEMATICS AND APPLICATIONS, DEPARTMENT OF MATHEMATICS, UNIVERSITY OF AVEIRO, 3810-193 AVEIRO, PORTUGAL

Email address: maria.elisa@ua.pt

UNIVERSITÉ LIBRE DE BRUXELLES, DÉPARTEMENT DE MATHÉMATIQUE, C.P.216 - ALGÈBRE ET COMBINATOIRE, BOULEVARD DU TRIOMPHE, 1050 BRUSSELS, BELGIUM

Email address: dleemans@ulb.ac.be

DEPARTMENT OF APPLIED MATHEMATICS, WENTWORTH INSTITUTE OF TECHNOLOGY, BOSTON, MASSACHUSETTS 02115

Email address: mixerm@wit.edu